

# Kaadas

Access to your Future !

## K9 User Manual

www.kaadasgroup.com

Shenzhen Kaadas Intelligent Technology Co.,Ltd reserves all rights for the final interpretation to this user manual.

All design and specifications are subject to change without notice.

### 1 CAUTIONS

This section contains important information to ensure the user's safety and prevent potential damage to property. Please, read this section carefully and use the product accordingly.

#### CAUTION

- Master PIN Code: Default Master PIN code is [12345678], please modify it immediately.
- User PIN Code: It can be 6-12 digits number. You can register and up to 10 users.

User Number	User Type	Notes
00 - 04	Normal User	*Permanent
05 - 08	Temporary User	*Invalid after using one time or in safety mode
09	Duress User	*Working with wireless module when duress event occurs

- Card: It is optional. Maximum capacity is 100 with user number [00-99].
- Fingerprint: Maximum capacity is 100 with user number [00-99].
- Be sure to correctly match the poles (+/-) when installing the batteries. Install the batteries with the correct poles (+/-).
- Replace all batteries immediately after they run out of power, and never mix new batteries with used ones.

#### Overview

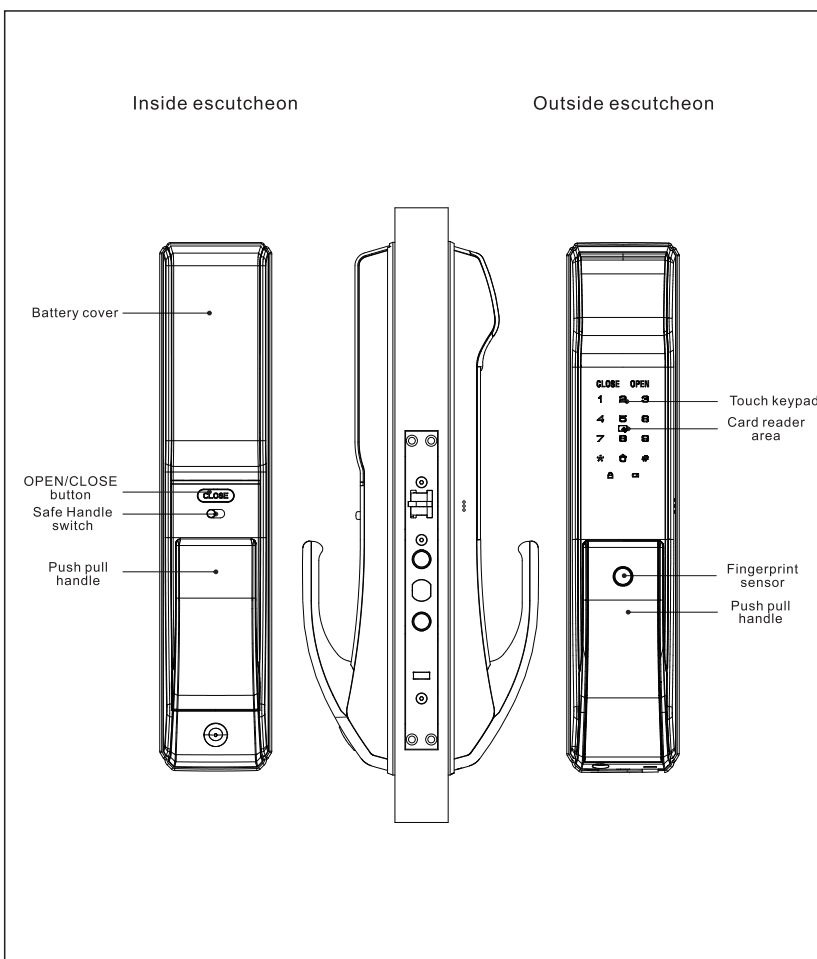

#### Bottom view

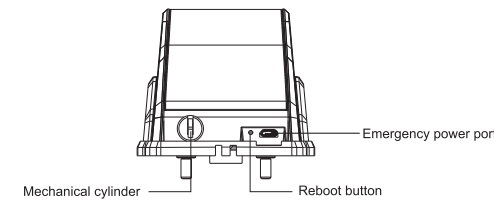

#### Mortise

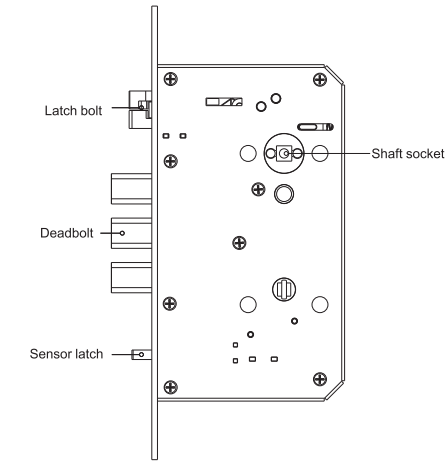

#### Key override

#### CAUTION

The product components used may vary depending on the installation environment and model number.

### 2 Package Content and Explosive View

This described package content is for reference only, the real products should be considered as final. If some components lost, please check with the sellers.

Number	Item name	Quantity	Remark
1	Outside escutcheon	1	
2	Inside escutcheon	1	
3	Mortise	1	
4	Screw pack	1	
5	User manual	1	
6	Warranty card	1	
7	Key box	1	2 keys
8	Strike assembly	1	
9	Installation template	1	
10	Mounting plate	1	
11	RFID Card	2	

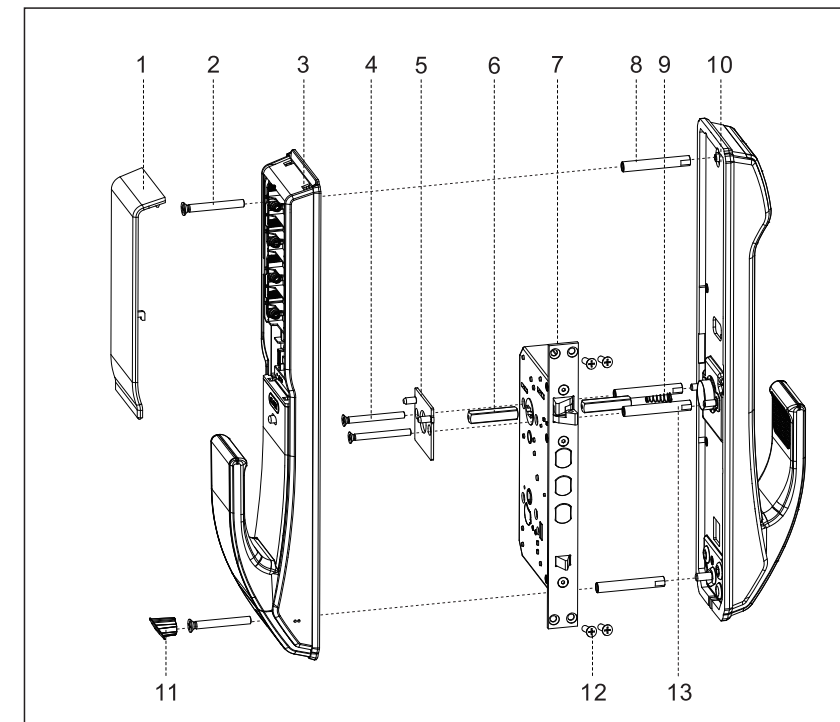

- Battery cover
- Mounting screw (2 pcs)
- Inside escutcheon assembly
- Mounting plate screw (2 pcs)
- Mounting plate
- Square shaft (2 pcs)
- Mortise
- Connecting screw bolt (2 pcs)
- Pressure spring
- Outside escutcheon assembly
- Rubber plug
- Fixed screw (4 pcs)
- Connecting screw bolt (2 pcs)

### 3 Before Installation

- Confirm open direction  
This product can be installed on left-in, left-out-right-in, and right-out doors.

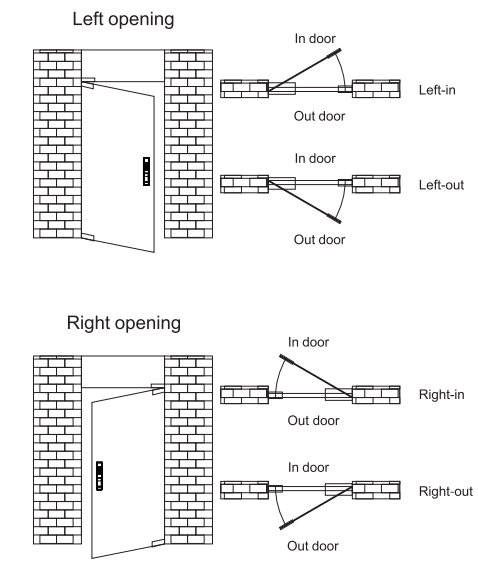

- Change open direction  
Please change position of screws according to open direction.

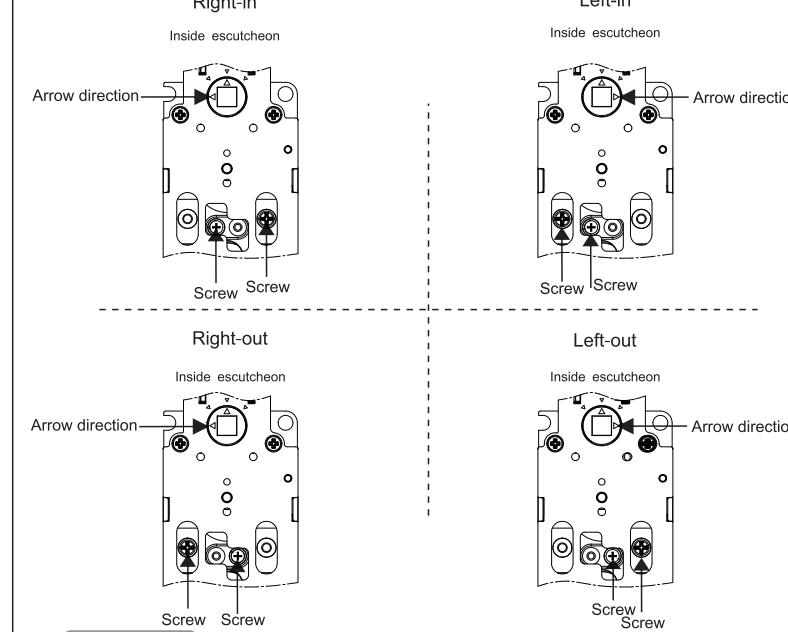

- Please choose correct screw pack according to your door thickness.
- Default screw pack is for door thickness 38-60mm, please contact our dealer if other screw pack required.

#### CAUTION

After installing the strike assembly, please check if the lock works smoothly by opening/closing door.

### 4 Installation

- Mark and drill bores by using the installation template first, then fix the mortise into the door frame.
- Tighten the 4 screws to fix the mortise on the door.
- Fix 5 screw bolts on the front escutcheon, place square shaft and pressure spring into the bore.
- Pass the connection wire through the top bore. Then align and insert square shaft into mortise holes to make the front escutcheon against the door closely.
- Install the mounting plate with fixing screws tightly against the door surface.
- Place square shaft in the back escutcheon in proper order.
- Insert the connecting wires of front escutcheon into the related sockets of the back escutcheon. Then align and insert the square shaft into mortise hole, make the back escutcheon against the door closely.
- Tighten the 2 fixing screws.
- Install the batteries and the battery cover. Covers the rubber plug, then install the striker assembly to finish installation.
- Please check push-pull handle, safe handle switch and mechanical key if they are working properly.

**Notes:**  
1. You can operate following the voice guide.  
2. The length of both master PIN code and user PIN code is 6-12 digits  
3. Enter [400#] will get Serial Number.

### 5 How to set up your product

- How to access into master mode

- Touching the keypad area will light up number pad.
- Press [\*] (" twice), then enter master PIN code [default is 12345678] with end of [#]. Voice prompt "Master mode"

#### Notes

Change master PIN code is required immediately for menu operation.

- Menu table

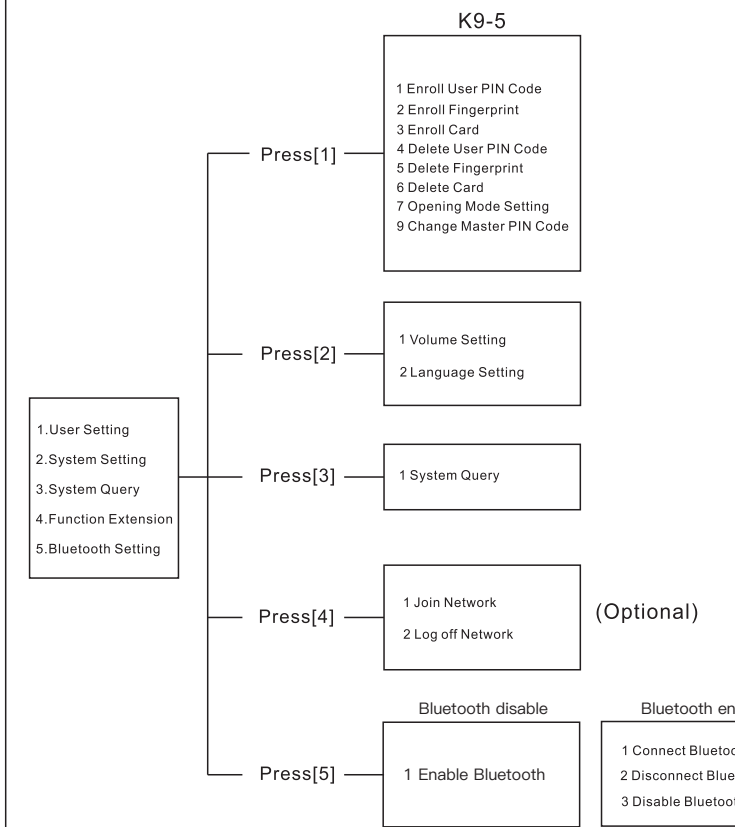

#### Notes

- You can operate following the voice guide.
- The length of both master PIN code and user PIN code is 6-12 digits
- Enter [400#] will get Serial Number.

#### User settings

##### Enroll User PIN Code

- Access into master mode, press [1] for user setting. Then press [1] to enroll user PIN code.
- Enter 2 digital user number (00-99), and confirm with [#] key.
- Enter user PIN code (6-12 digits), and confirm with [#] key. Then repeat above operations. Voice prompt "settings succeed".

#### Notes

Refer to 1 Cautions [00-04] : Normal User [05-08] : Temporary User [09] : Duress User

##### Enroll Fingerprint (optional)

- Access into master mode, press [1] for user setting. Then press [2] to enroll user fingerprint.
- Enter 2 digital user number (00-99), and confirm with [#] key.
- Place your finger on the fingerprint sensor, then take away your finger after voice prompt "Remove finger and scan again". Repeat above steps multiple times until voice prompt "settings succeed".

#### Notes

Refer to 1 Cautions [00-94] : Regular fingerprint [95-99] : Duress fingerprint

##### Enroll Card

- Access into master mode, press [1] for user setting. Then press [3] to enroll user card.
- Enter 2 digital user number (00-99), and confirm with [#] key.
- Place card on the card icon area until beep sound and voice prompt "settings succeed".

纸张: 128g铜版纸双面单黑印刷

工艺: 风琴7折, 折后尺寸125\*265mm

### Delete User PIN Code

- 1 4** Access into master mode, press [1] for user setting. Then press [4] to delete user PIN code.
- 1** Press [1] to delete single user
- 1 2 3 4 5 6 7 8 9 #** Enter 2 digital user number (00-09), and confirm with [#] key. Voice prompt of "Deletion succeeded"
- 2** Press [2] to delete all users. Voice prompt of "Deletion succeeded"

### Delete User Fingerprint

- 1 5** Access into master mode, press [1] for user setting. Then press [5] to delete user fingerprint.
- 1** Press [1] to delete single user
- 1 2 3 4 5 6 7 8 9 #** Enter 2 digital user number (00-99), and confirm with [#] key OR Place the related finger on the fingerprint sensor to delete until one beep sound. Voice prompt of "Deletion succeeded"
- 2** Press [2] to delete all users. Voice prompt of "Deletion succeeded"

### Delete User Card

- 1 6** Access into master mode, press [1] for user setting. Then press [6] to delete user card.
- 1** Press [1] to delete single user
- 1 2 3 4 5 6 7 8 9 #** Enter 2 digital user number (00-99), and confirm with [#] key OR Place the related RF card on the card icon area to delete until one beep sound. Voice prompt of "Deletion succeeded"
- 2** Press [2] to delete all users. Voice prompt of "Deletion succeeded"

### Opening Mode Setting

- 1 7** Access into master mode, press [1] for user setting. Then press [7] for opening mode setting.
- 1** Press [1] for normal mode (single verification), which means opening by PIN code or fingerprint or card.
- 2** Press [2] for security mode (double verification), which means opening by PIN code+fingerprint or PIN code+card or fingerprint+card

**Notes**  
In security mode, to delete all users is prohibited

### Change Master PIN Code

- 1 9** Access into master mode, press [1] for user setting. Then press [9] to change master PIN code.
- 1 2 3 4 5 6 7 8 9 #** Enter new master PIN code (6-12 digits) and confirm with [#] key. Then repeat above operations. Voice prompt of "settings succeed"

**Notes**  
Change master PIN code is required immediately after installation.

### System Setting

#### Volume Setting

- 2 1** Access into master mode, press [2] for system setting. Then press [1] for volume setting.
- 1** Press [1] for voice mode.
- 2** Press [2] for mute mode, excluding alarm and menu operation.

### Language Setting

- 2 2** Access into master mode, press [2] for system setting. Then press [2] for language setting.
- 1** Press [1] for Chinese Voice.
- 2** Press [2] for English Voice.
- 3** Press [3] for Spanish Voice.
- 4** Press [4] for Portuguese Voice.
- 5** Press [5] for Russian Voice.

### System Query

- 3** Access into master mode, press [3] for system query.
- 1** Press [1] to get unique Serials Number.

### Function Extension

- 4** Access into master mode, press [4] for bluetooth setting.
- 1** Press [1] to Join Network.
- 2** Press [2] to Log off Network.

### Bluetooth Setting

- 5** Access into master mode, press [5] for bluetooth setting.
- 1** Press [1] to connect bluetooth.
- 2** Press [2] to disconnect bluetooth.
- 3** Press [3] to disable bluetooth. After that, press [1] to enable bluetooth.

## 6 How to use your lock

### 6.1 Normal Mode

#### PIN code opening



1. Touch pad screen by palm to lighten keypad
2. Enter the enrolled PIN code with end of [#]. Voice prompt "door opened"
3. Push or Pull handle to open the door

**Notes**  
The random numbers can be added before and after the real PIN code, this prevents the user PIN code from being exposed. The maximum length is 32 digits.

#### Fingerprint opening

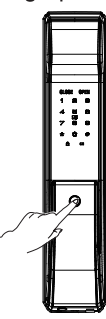

1. Place the enrolled finger properly on the fingerprint sensor area until one beep sound and voice prompt "door opened"
2. Push or Pull handle to open the door

#### Card opening

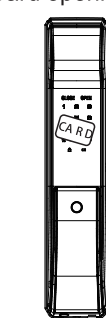

1. Place the enrolled card properly on the card icon area until one beep sound and voice prompt "door opened"
2. Push or Pull handle to open the door

### 6.2 Security mode

In security mode, double verification is required for opening door.



1. PIN Code + Fingerprint
2. PIN Code + Card
3. Fingerprint + Card

### 6.3 Open door by mechanical key override

In case of forgetting PIN code, battery run out or system error; Mechanical key is used to open door as backup mode.

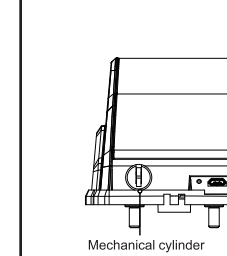

Insert the key into key hole and rotate it with proper angles. Then push or pull handle to open the door.

### 6.4 Auto /Manual Mode

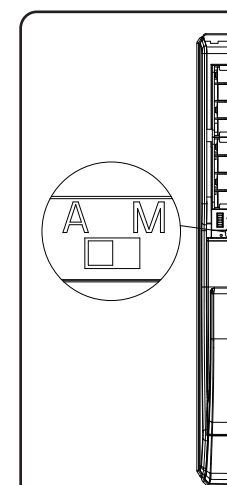

1. Taking out battery cover to find the A/M switch.
2. [A] means auto mode: when door is closed, the deadbolt will be driven out automatically, then door will be in locked status.
3. [M] means manual mode: when door is closed, the deadbolt will not be driven out, then the door will be in unlocked status.

**Notes**  
In manual mode, once the door is closed, please verify user fingerprint/PIN code / card to lock the door from outside.

### 6.5 CLOSE button

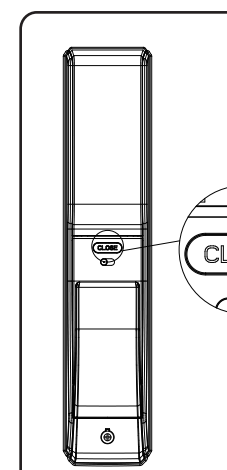

1. Click [CLOSE] button to lock the door.
2. Double click [CLOSE] button to open the door.
3. Long press [CLOSE] button to double lock the door. The privacy mode will be enabled, only Master PIN code and key can open the door from outside. User PIN code / Fingerprint / Card is prohibited.

### 6.6 Locking Operation

#### Auto locking

In auto mode, door will be locked automatically in 1.5 seconds after closing. Voice prompts "door closed"

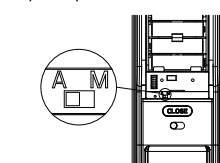

#### Manual locking

In manual mode, click [CLOSE] button to lock the door from inside or verify user fingerprint / PIN code / card to lock the door from outside. Voice prompts "door closed"

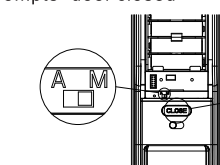

#### Double locking

When door is locked, long press [CLOSE] button to double lock the door. Voice prompts "inside deadlock enabled"

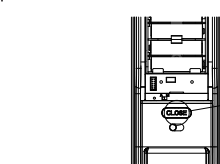

**Notes**

1. In normal mode, when entering 5 times a wrong user PIN code, card and fingerprint within 5 minutes, the lock is suspended 2 minutes.
2. In security mode, if there are 5 consecutive incorrect inputs of either of the 2 types of verification methods (PIN code/card/fingerprint), the system will be locked for 2 minutes.

### 6.7 Defense Mode

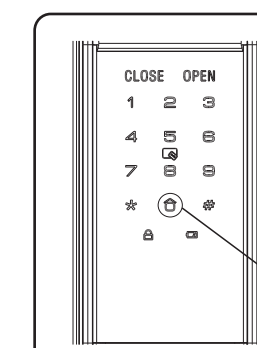

1. Enable: After door is locked, press [e] button to enable defense mode. Voice prompt "Outside forced lock enabled". In this mode, when the door is unlocked from inside, the alarm will be triggered.
2. Disable: Once the door is opened properly from outside, the defense mode will be disabled.

### 6.8 Safe Handle Feature

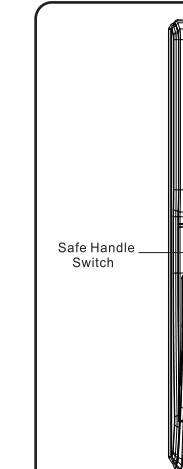

1. Enable: move the safe handle switch to display "red mark". Once safe handle feature is enabled, the indoor handle will be locked.
2. Disable: move the safe handle switch to display "green mark". The indoor handle can be pushed or pulled freely.

### 6.9 Mute/Voice Switch

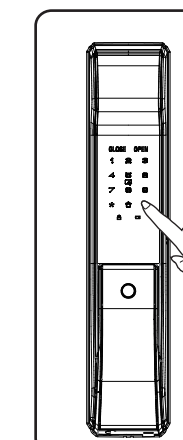

Voice > Mute : When default setting is voice mode, long press [#] button to enable mute mode. After the lock go back to sleeping status, mute mode will be disabled automatically.  
Mute > Voice : When default setting is mute mode, long press [#] button to enable voice mode. After the lock go back to sleeping status, voice mode will be disabled automatically.

### 6.10 Restore To Factory Setting

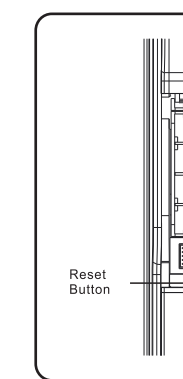

- Operation instructions:
1. Open battery cover and find the reset button.
  2. Double click [RES] button, then voice prompt "Restored to factory settings. Change master PIN code."
  3. After that all user data and settings will be deleted.

**Notes**  
After the lock is restored to factory setting, all users and settings will be cleared. The master PIN code will be changed into [12345678] and required for changing immediately.

### 6.11 Emergency Power Supply

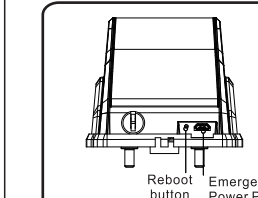

When the battery voltage is too low to open the lock from outside, you can use 5V power bank to charge the door lock via Micro USB port. After the door is unlocked, please replace all batteries immediately. When the lock system crash down, you can restart system by pressing the reboot button.

**Notes**  
When battery voltage is lower than 4.8V, voice prompts "Low battery, please replace all batteries" at each unlocking. Please replace all batteries immediately, and do not mix old batteries and new batteries together in replacement.

### 6.12 Replace Battery

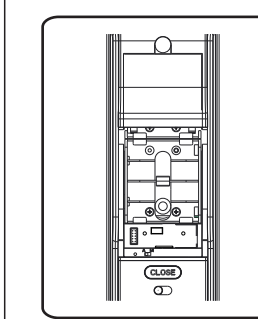

1.5V AA Alkaline Battery is required. Total is 8 pcs, divided into 2 groups. One group is ok for power supply, two groups is used for longer time.

### 6.13 Extended Function(optional)

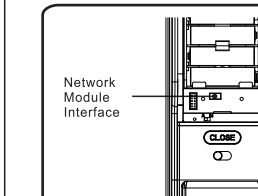

Access into master mode, press [4] for function extension, which is reserved for Z-Wave and other smart home interface. Please contact Kaadas distributor for more details.

**Notes**  
When closing the door, please mind the gap between door frame and Push-Pull handle. Do not jam your hand.

